



THE VAN RACKING SPECIALISTS
LOS ESPECIALISTAS DE LOS
EQUIPAMIENTOS PARA FURGONETAS



Cases Maletines

Metal component cases

Maletines en metal

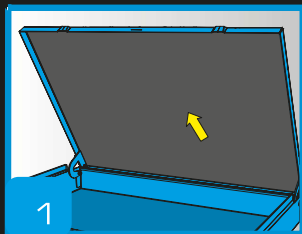
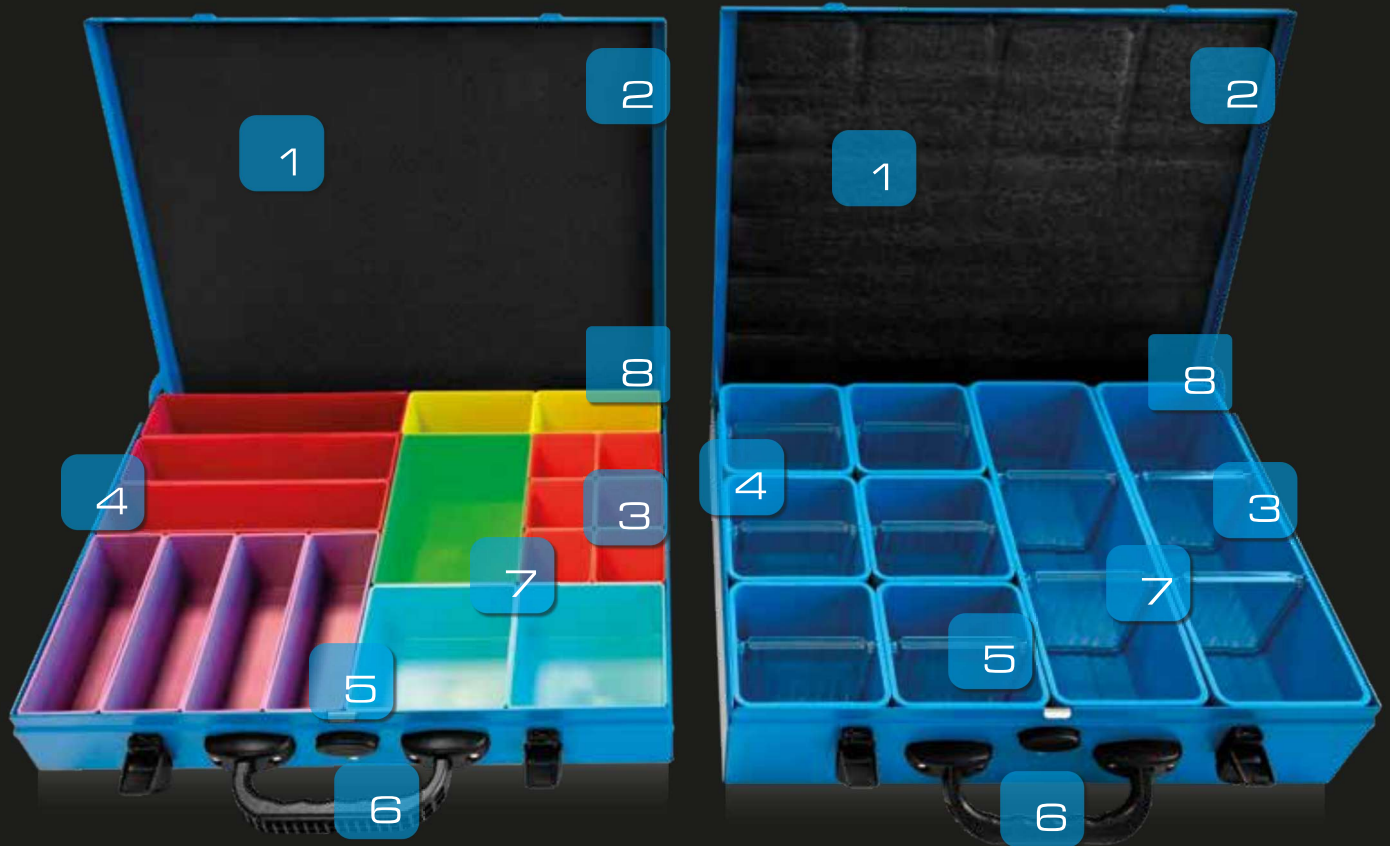

An expanded resin lid liner keeps everything where you put it

Resina expandida dentro de la tapa contra la mezcla del contenido.

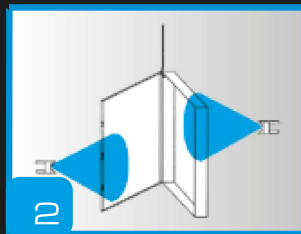

Oven-cured powder paint finish

Barnizado con polvos termoendurecedores

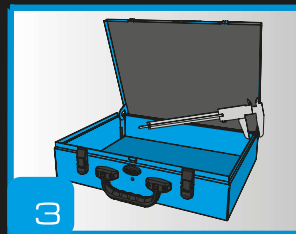

0,8/0,9 mm thick steel sheet
Grosor chapa 0,8/0,9 mm

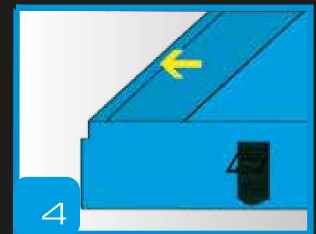

Safe, rounded edges

Rebordes plegados anticorte

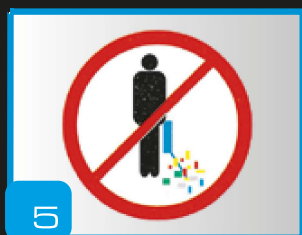

Safety catch to prevent accidental opening

Gancho de seguridad contra la apertura accidental

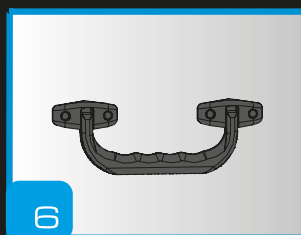

Robust plastic handle

Robusto tirador en plástico

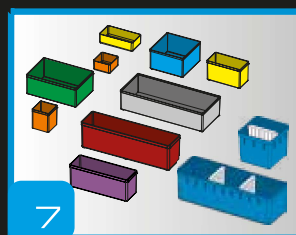

9 freely arrangeable modular trays

9 bandejas modulares y componibles libremente

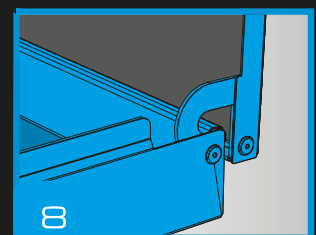

New anti-tip hinge stops the lid falling backwards

Nueva bisagra antivuelco que impide la apertura completa de la tapa



Metal tool case Maletín en metal

391x283x66 mm

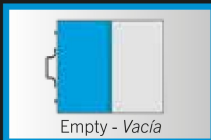
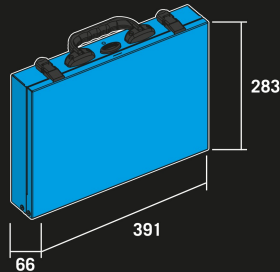

Code / Código XMS10231

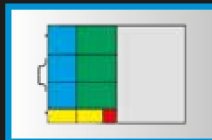

Code / Código KMS10231KPC09



Code / Código KMS10231KPC10

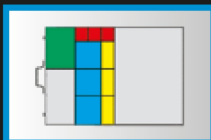

Code / Código KMS10231KPC11

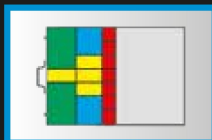

Code / Código KMS10231KPC15

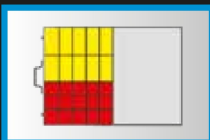

Code / Código KMS10231KPC25

	Model of container Modelo bandejas	Number of containers Cantidad bandejas	Metal tray and dividers Bandeja y divisores en metal	Quantity - Cantidad
XMS10231	/	/	/	/
KMS10231KPC09	P4030	1	/	/
	P4040	2	/	/
	P4050	3	/	/
	P4060	3	/	/
KMS10231KPC10	P4030	3	/	/
	P4040	2	/	/
	P4050	2	/	/
	P4060	2	/	/
	P4065	1	/	/
KMS10231KPC11	P4030	3	/	/
	P4040	3	/	/
	P4050	3	/	/
	P4060	1	/	/
	P4065	1	/	/
KMS10231KPC15	P4030	7	/	/
	P4040	4	/	/
	P4050	2	/	/
	P4060	2	/	/
KMS10231KPC25	P4030	15	/	/
	P4040	10	/	/

Metal tool case Maletín en metal

444x283x66 mm

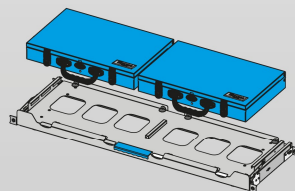
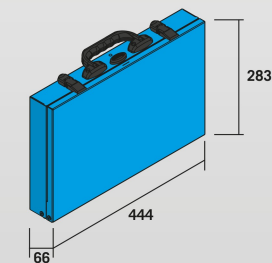

Only compatible with the 310 mm deep double-tray.

Entra solamente en la bandeja doble de 310 mm de profundidad.

	Model of container Modelo bandejas	Number of containers Cantidad bandejas	Metal tray and dividers Bandeja y divisores en metal	Quantity - Cantidad
XMS20231	/	/	/	/
KMS20231KPC08	P4050	4	/	/
	P4060	4	/	/
KMS20231KPC13	P4030	8	/	/
	P4050	1	/	/
	P4060	2	/	/
	P4065	2	/	/
XMS20231KPC19	P4030	10	/	/
	P4040	5	/	/
	P4050	2	/	/
	P4060	2	/	/
KMS20231KPC24	P4030	16	/	/
	P4040	4	/	/
	P4050	4	/	/
KMS20231KPC30	P4030	20	/	/
	P4040	10	/	/

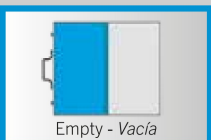

Code / Código XMS20231



Code / Código KMS20231KPC08

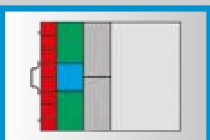

Code / Código KMS20231KPC13

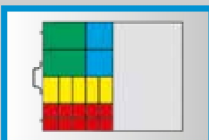

Code / Código XMS20231KPC19

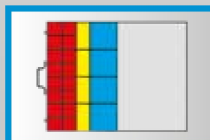

Code / Código KMS20231KPC24

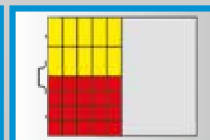

Code / Código KMS20231KPC30

Metal tool case
Maletín en metal

444x337x66 mm



Model with space dividers
Modelo con divisores

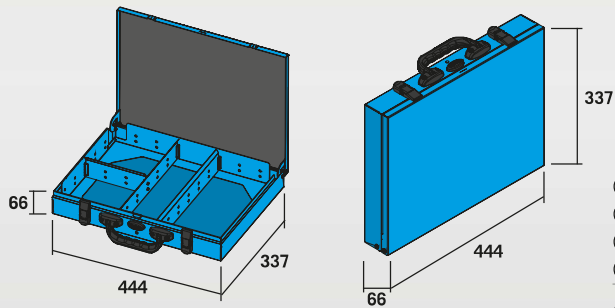

Code/Código XMS20236 x 1 +
Code/Código ADV00011 x 1 +
Code/Código ADV00012 x 2 +
Code/Código ADV00013 x 1 =

Code/Código XMS20236KDVO3

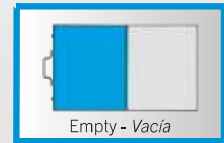

Empty - Vacía

Code / Código XMS20236

Code / Código KMS20236KDVO3

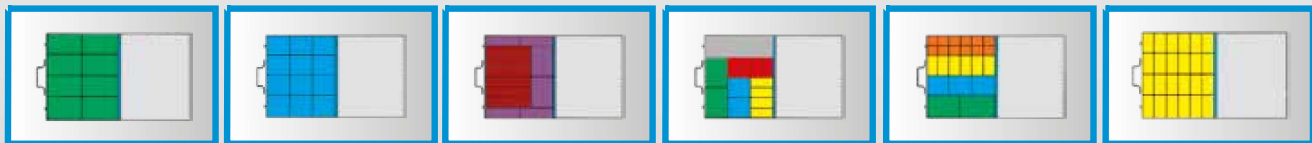

Code / Código KMS20236KPC08

Code / Código XMS20236KPC12

Code / Código KMS20236KPC14

Code / Código KMS20236KPC17

Code / Código XMS20236KPC23

Code / Código XMS20236KPC24

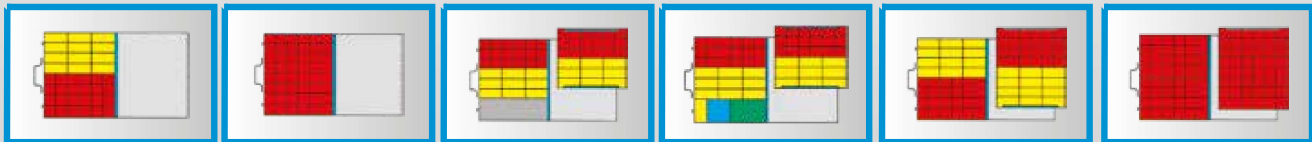

Code / Código KMS20236KPC36

Code / Código XMS20236KPC48

Code / Código KMS20236KPC54

Code / Código KMS20236KPC57

Code / Código KMS20236KPC72

Code / Código KMS20236KPC96

	Model of container Modelo bandejas	Number of containers Cantidad bandejas	Metal tray and dividers Bandeja y divisores en metal	Quantity - Cantidad
XMS20236	/	/	/	/
KMS20236KPC08	P4060	8	/	/
XMS20236KPC12	P4060	12	/	/
KMS20236KPC14	P2060	8	/	/
	P2065	6	/	/
KMS20236KPC17	P4030	8	Z4080	1
	P4040	4	/	/
	P4050	2	/	/
	P4060	2	/	/
XMS20236KPC23	P4030	12	/	/
	P4040	6	/	/
	P4050	3	/	/
	P4060	2	/	/
XMS20236KPC24	P4040	24	/	/
KMS20236KPC36	P4030	24	/	/
	P4040	12	/	/
XMS20236KPC48	P4030	48	/	/
KMS20236KPC54	P4010	36	Z4070	1
	P4020	18	Z4080	1
KMS20236KPC57	P4010	36	Z4070	/
	P4020	18	/	/
	P4040	1	/	/
	P4050	1	/	/
	P4060	1	/	/
KMS20236KPC72	P4010	48	Z4072	1
	P4020	24	/	/
KMS20236KPC96	P4010	96	Z4072	1

Metal nozzle case
Maletín en metal con bandeja metálica porta ojalos

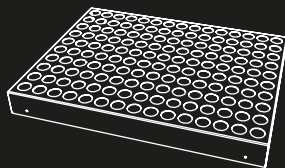

Code/Código XMS20236 x 1 +
Code/Código S4092 x 2 +
Code/Código ANH00002 x 1 =

**Code/Código
KMS20236KNH02**



KMS20236KNH02

Code/Código	Description/Descripción	Dimensions/Medidas
ANH00002	Metal case with holes for 150 nozzles Bandeja metálica porta ojalos para 150 alojamientos	440x330

Metal tool case Maletín en metal

444x337x100 mm

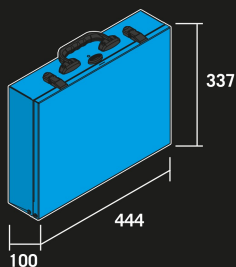

Model with space dividers
Modelo con divisores

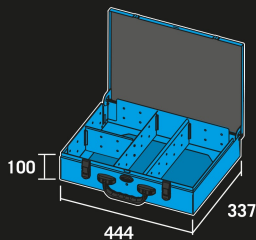

Code/Código XMS20336KDV03

Code/Código XMS20336 x 1 +
Code/Código ADV00014 x 1 +
Code/Código ADV00015 x 2 +
Code/Código ADV00016 x 1 =

Code/Código XMS20336KDV03

	Model of container Modelo bandejas	Number of containers Cantidad bandejas	Metal tray and dividers Bandeja y divisores en metal	Quantity - Cantidad
XMS20336	/	/	/	/
KMS20336KPC39	P4010	18	Z4070	1
	P4020	9	Z4082	1
	P4040	6	/	/
	P4050	3	/	/
	P4060	2	/	/
XMS20336KPC48	P4010	24	Z4072	1
	P4020	12	Z4080	1
	P4040	6		
	P4050	3		
	P4060	2		
KMS20336KPC50	P4010	24	Z4072	1
	P4020	12	/	/
	P2060	8	/	/
	P2065	6	/	/
	XMS20336KPC59	P4010	24	Z4072
	P4020	12	/	/
	P4030	12	/	/
	P4040	6	/	/
	P4050	3	/	/
	P4060	2	/	/



Empty - Vacía

Code / Código XMS20336

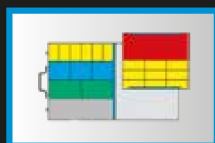

Code / Código KMS20336KPC39



Code / Código XMS20336KPC48

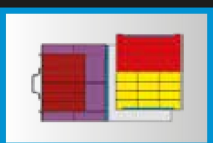

Code / Código KMS20336KPC50

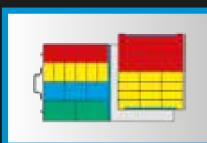

Code / Código XMS20336KPC59

Metal tool case Maletín en metal

444x337x100 mm
with 96 mm trays /
con bandejas de 96 mm



	Model of container Modelo bandejas	Number of containers Cantidad bandejas
XMS20336KPC04	P5050	/
	P5070	4
XMS20336KPC06	P5050	3
	P5070	3
XMS20336KPC08	P5050	6
	P5070	2
XMS20336KPC10	P5050	9
	P5070	1
XMS20336KPC12	P5050	12
	P5070	/

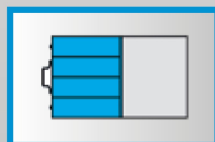

Code / Code XMS20336KPC04

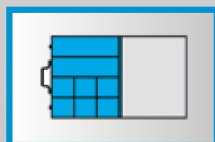

Code / Code
XMS20336KPC08

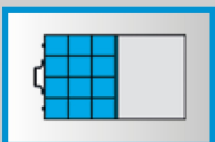

Code / Code
XMS20336KPC12

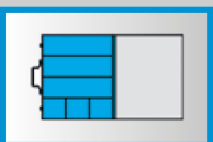

Code / Code
XMS20336KPC06

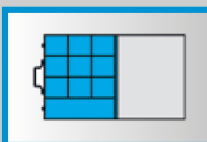

Code / Code
XMS20336KPC10

Metal tool case Maletín en metal

444x337x130 mm

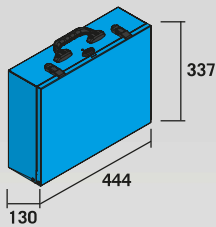

Model with space dividers
Modelo con divisores

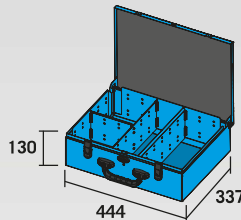

Code / Código XMS20436KDV03

Code/Código XMS20436 x 1 +
Code/Código ADV00017 x 1 +
Code/Código ADV00018 x 2 +
Code/Código ADV00019 x 1 =

Code/Código XMS20436KDV03

	Model of container Modelo bandejas	Number of containers Cantidad bandejas	Metal tray and dividers Bandeja y divisores en metal	Quantity - Cantidad
XMS20436	/	/	/	/
KMS20436KPC30	P4030	12	Z4074	1
	P4040	6	/	/
	P4050	4	/	/
	P4060	4	/	/
	P4065	4	/	/
KMS20436KPC37	P4030	12	Z4074	1
	P4040	6	/	/
	P4050	3	/	/
	P4060	2	/	/
	P2060	8	/	/
	P2065	6	/	/
XMS20436KPC42	P4030	24	Z4074	1
	P4040	8	Z4080	1
	P4050	5	/	/
	P4060	4	/	/
KMS20436KPC44	P4030	24	Z4074	1
	P4040	12	/	/
	P4060	4	/	/
XMS20436KPC46	P4030	24	Z4074	1
	P4040	12	/	/
	P4050	6	/	/
	P4060	4	/	/

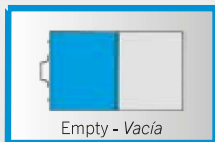

Code / Código XMS20436



Code / Código KMS20436KPC30

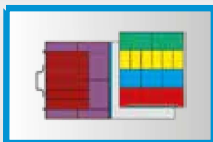

Code / Código KMS20436KPC37



Code / Código XMS20436KPC42

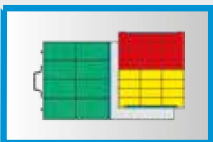

Code / Código KMS20436KPC44



Code / Código XMS20436KPC46

Metal toolbox Maletín en metal

444x337x173 mm

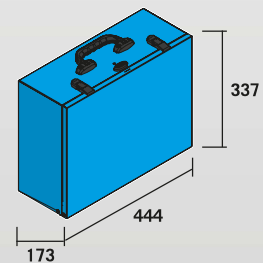

Model with space dividers
Modelo con divisores

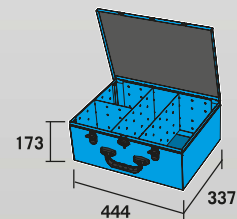

Code / Código XMS20536KDV03

Code/Código XMS20536 x 1 +
Code/Código ADV00020 x 1 +
Code/Código ADV00021 x 2 +
Code/Código ADV00022 x 1 =

**Code/Código
XMS20536KDV03**



Code / Código XMS20536 - 4,23 kg

Galaxy plastic component cases are innovative in design and function. With their tapering sides, these hydrocarbon-resistant cases boast a series of features that make them stand out from conventional alternatives:

- Broader base for improved impact protection
- Grooves in the bottom for metal space dividers and/or plastic containers
- Designed to lie down or stand on edge, stackable

Los maletines en plástico Galaxy son innovadores tanto desde el punto de vista estético como funcional.

Realizados en tronco de cono, en plástico resistente a los hidrocarburos, presentan una serie de características que los hacen ser únicos respecto a los maletines presentes en el mercado:

- fondo destacado respecto a la tapa, para una mayor protección de los golpes.
- protuberancias en el fondo para introducir los divisores metálicos y/o las bandejas de plástico.
- diseño que permite un apoyo seguro en vertical o en horizontal, con posibilidad de apilar varios maletines uno encima de otro.



Transparent cover for a clear view of contents
Tapa transparente con total visibilidad del contenido

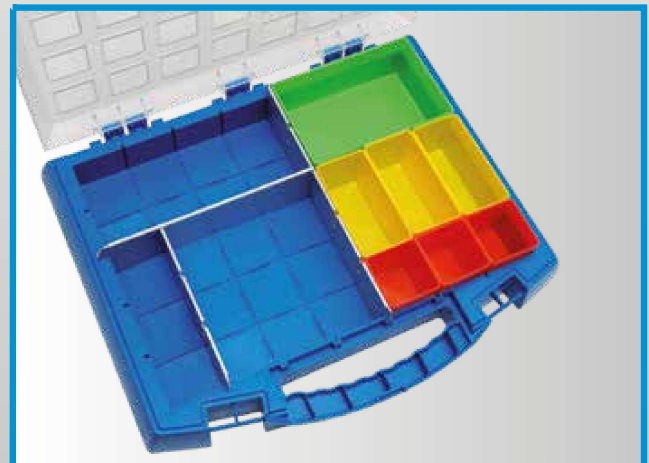

Interior can be customised with a variable number of dividers and containers.
Interno personalizable con número variable de divisores y bandejas.



Fully compatible with Syncro System case trays and sloping case shelves.

Compatibilidad total con bandejas porta maletines de cajonera y repisas inclinadas de estantería Syncro System.

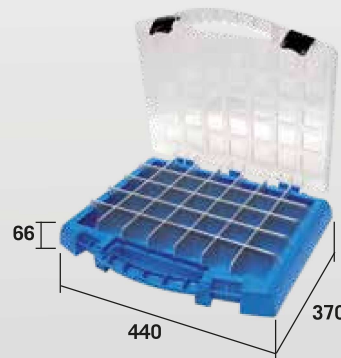
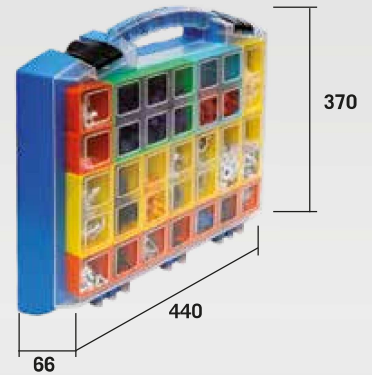

Code / Código VP6601

Code/Código VP6600 x 1 +
Code/Código VP6600.DIVC x 6 +
Code/Código VP6600.DIVL x 4 =

Code/Código VP6601

Design allows case to lie down or stand on edge and permits multiple cases to be stacked one on top of another.

Diseño que permite un apoyo seguro en vertical o en horizontal, con posibilidad de apilar varios maletines uno encima de otro.

Model of container Modelo bandejas	Number of containers Cantidad bandejas	Metal tray and dividers Bandeja y divisores en metal	Quantity - Cantidad
---------------------------------------	---	---	---------------------

VP6600	/	/	/	/
VP6608	P4030	5	/	/
	P4050	3	/	/
	/	/	VP6600.DIVC	/
	/	/	VP6600.DIVL	1
VP6610	P2060	5	/	/
	P2065	5	/	/
VP6612	P4030	5	/	/
	P4040	3	/	/
	P4050	2	/	/
	P4065	2	/	/
VP6613	P4030	7	/	/
	P4050	4	/	/
	P4060	2	/	/
VP6617	P4030	7	/	/
	P4040	7	/	/
	P4050	2	/	/
	P4060	1	/	/
VP6621	P4030	7	/	/
	P4040	14	/	/
VP6635	P4030	35	/	/



Empty - Vacía

Code / Código VP6600

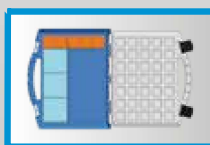

Code / Código VP6608

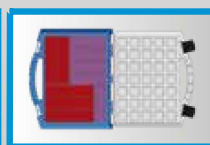

Code / Código VP6610



Code / Código VP6612

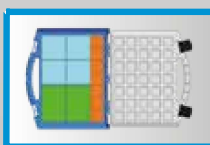

Code / Código VP6613

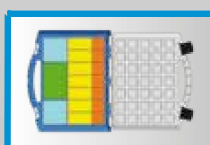

Code / Código VP6617

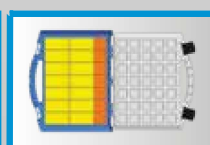

Code / Código VP6621

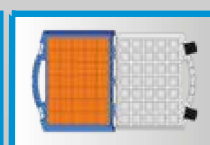

Code / Código VP6635

Professional aluminium tool case

Maletín profesional en aluminio



Extremely lightweight and robust professional tool case in ABS and aluminium.

- Sides in electric blue ABS, edge profiles in anodised aluminium, complete with lockable latches and steel hinge
- Internal equipment includes document pocket, tool pockets and elastic straps and bottom with 3 dividers
- Dimensions of 440x330x173 mm permit easy insertion in Syncro System case cabinets.

Ligerísimo y robusto maletín profesional Syncro en ABS y aluminio.

- Paredes en ABS azul eléctrico, perfiles en aluminio anodizado, con cierres con llave y bisagras en acero.
- Equipamiento interno con bolsa para documentos, bolsillos y elásticos para herramientas y fondo con 3 divisores.
- Las dimensiones 440x330x173 mm permiten introducir las cajoneras Syncro System

Code/Código	Description/Descripción	Dimensions/Medidas
VP4433	Professional aluminium tool case <i>Maletín profesional en aluminio</i>	440x330x173

Cases for power tools

Maletines para herramientas eléctricas

XMS10331

Case for drills and other small power tools. Complete with foam insert.
Dimensions: 391x100x283 mm

Maletín para taladradoras y pequeñas herramientas eléctricas. Con esponja.
Medidas 391x100x283 mm

Code / Código XMS10331



XMS20431

Case for large drills, Ø125 angle grinders, saws, sanders, etc. Complete with foam insert.
Dimensions: 444x132x283 mm

Maletín para taladradoras de grandes dimensiones, mini esmeriladoras Ø125, sierras, pulidoras, etc. Con esponja. Medidas 444x132x283 mm

Code / Código XMS20431



Case components and accessories

Componentes y accesorios para maletines

Metal trays for plastic containers

Bandejas en metal para cubetas

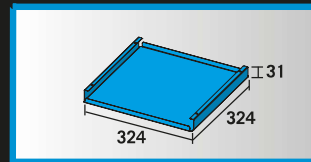
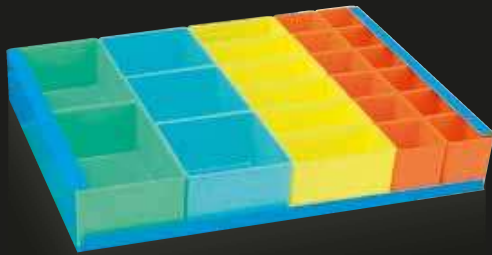

Code / Código Z4070

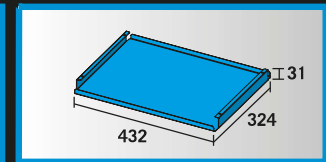

Code / Código Z4072

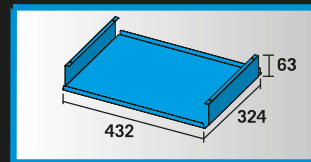

Code / Código Z4074

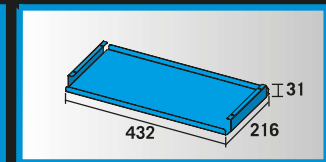

Code / Código Z4075

U-shaped metal space dividers

Divisores en metal en "u"

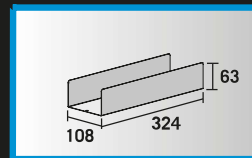

Code / Código Z4080

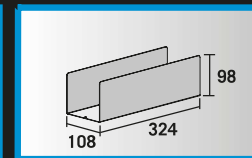

Code / Código Z4082

Plastic containers / Bandejas en plástico

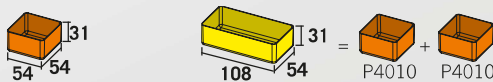

Code / Código P4010



Code / Código P4020

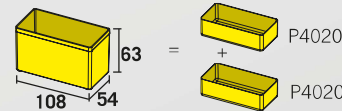

Code / Código P4040

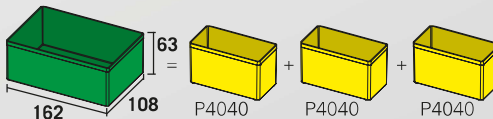

Code / Código P4060

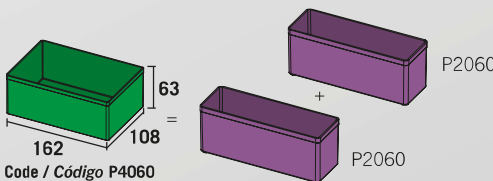

Code / Código P4060



Code / Código P4030

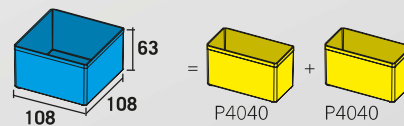

Code / Código P4050

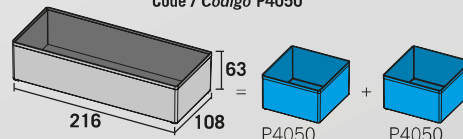

Code / Código P4065

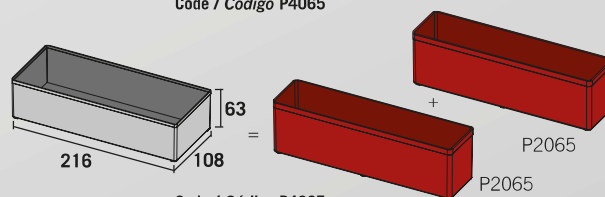

Code / Código P4065



Code / Código P4065

Foam inserts / Resina expandida

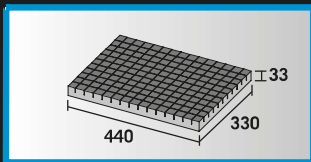

Code / Código S4092

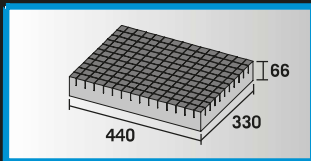

Code / Código S4094

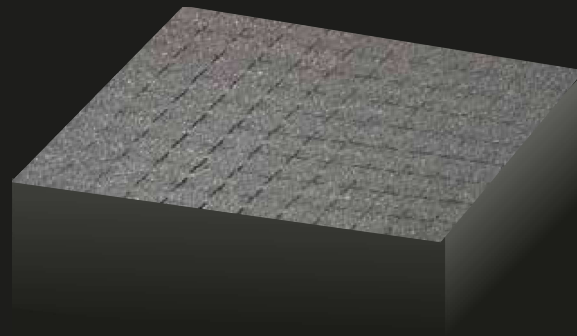

Case frame Contracajas con cremallera

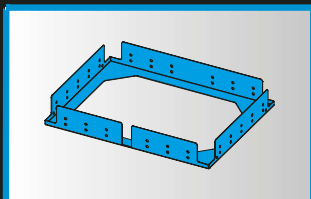

Code / Código ADV00011.R

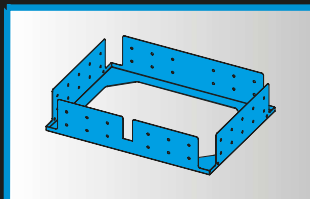

Code / Código ADV00014.R

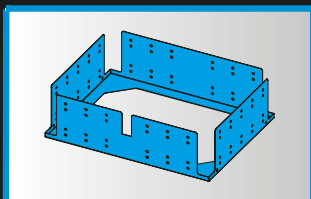

Code / Código ADV00017.R

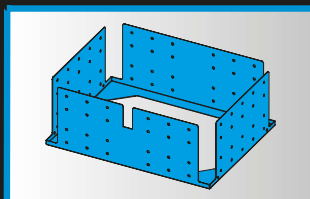

Code / Código ADV00020.R

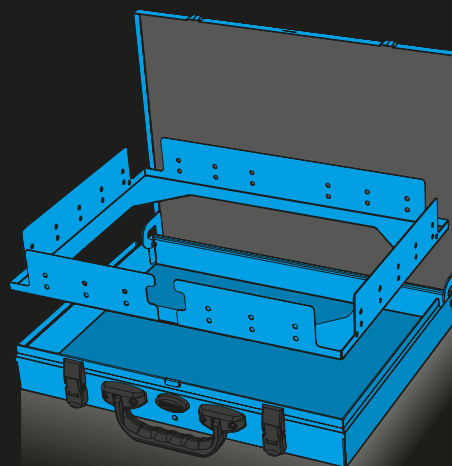

Space dividers for case frames Divisores para maletines con cremallera

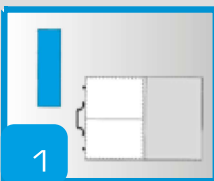

Crosswise divider
in aluminium
*Divisorio en aluminio
transversal*

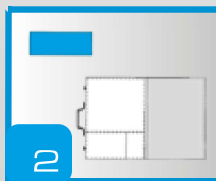

Short dividers
in aluminium
*Divisorio en aluminio
corto*

	1	2
Series / Serie KMS20236	ADV00012.R	ADV00013.R
Series / Serie KMS20336	ADV00015.R	ADV00016.R
Series / Serie KMS20436	ADV00018.R	ADV00019.R
Series / Serie KMS20536	ADV00021.R	ADV00022.R



